

**STEP 6.** Install jamb bracket so center line of bracket is plumb with center line of track. Bracket must rest firmly on the floor or on wood block if additional clearance is required for carpeting. Drill 7/64" pilot holes and secure to jamb with (2) 3/4" flat head screws and to floor with (1) 1-1/4" oval head screw.

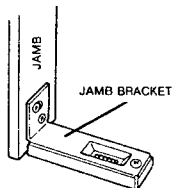

**STEP 7.** Grasp doors as shown. Guide top pivot into top pivot bracket hole. Lift door to compress top pivot and place bottom threaded pivot into bottom jamb bracket.

Depress Top Guide Roller Pivot and insert into track.

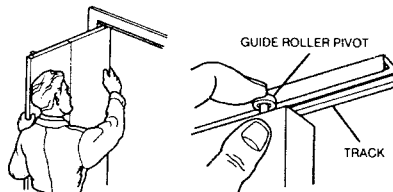

**STEP 8.** Vertical Adjustment - (IMPORTANT!) Lift door and screw out bottom threaded pivot until top clearance with track is minimal. This retains door in opening. Select adjuster hole to provide door with proper jamb and center clearance.

Horizontal Adjustment - If top pivot needs to be moved, remove door panel, loosen round head screw and move pivot bracket in or out to provide proper jamb clearance.

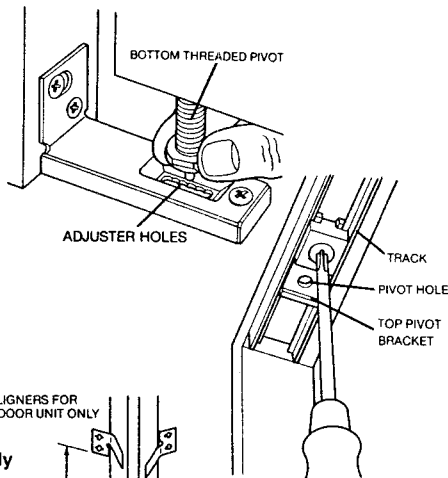

**STEP 9.** Install aligners on rear of 4 door unit only as shown using pan head screws. Drill 3/32" pilot holes and install. Adjust in or out until doors are aligned with each other. Tighten screws.

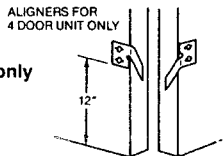

**National**<sup>®</sup>  
Hardware  
Makers  
Since 1901

**folding  
door  
hardware**

## Installation Instructions

390S and 390D FOLDING  
DOOR HARDWARE  
For 7/8" to 1-3/8" doors  
weighing up to 30lbs.  
each panel.

NATIONAL MANUFACTURING CO.  
STERLING, IL 61081

**STEP 1.** Prepare the opening size and door sizes as shown below. Finished opening height is door height plus 1-5/8". Allow additional clearance for carpeting. Finished opening width shall be 1/2" greater than the combined width of 2 doors, or 13/16" greater than the combined width of 4 doors.

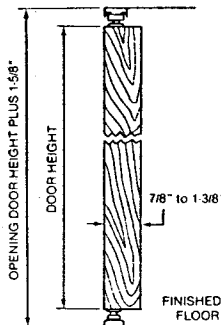

	2 DOOR DIMENSIONS			4 DOOR DIMENSIONS		
Finished Opening	2'0"	2'6"	3'0"	4'0"	5'0"	6'0"
Width of Each Panel	11-3/4"	14-3/4"	17-3/4"	11-3/4"	14-3/4"	17-3/4"
National Hardware	390S	24" to 36"		390D	390D	390D
				48"	60"	72"

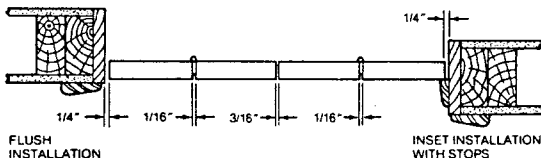

**STEP 2.** Set 2 doors on edge with the best faces opposite each other; space 5/16" apart. (This will provide 1/16" between panel edges when closed). Apply one hinge ten inches from each end with the third hinge centered between. Using hinge as template, spot holes, drill 7/64" pilot holes for 3/4" flat head screws and install.

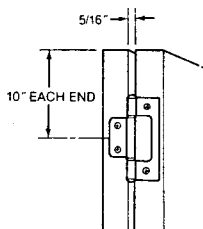

**STEP 3.** Drill 7/16" holes for top pivot, guide roller pivot and bottom threaded pivot at locations shown in drawing using metal template provided. Place template at door edge, center, and attach loosely with two small nails. Drill 7/16" holes 2 inches deep. Remove template. Repeat procedure for each hole drilled.

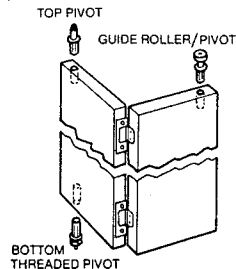
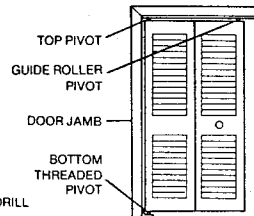
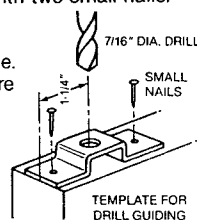

**STEP 4.** Compress top pivots and tap lightly with hammer into place. Snap guide roller onto pivot pin. Tap bottom threaded pivot into place.

**STEP 5.** Both sets: Mount track so face of door is flush with or slightly recessed from the opening face. Drill 7/64" pilot holes and install track with 3/4" round head screws. Assemble bumper spring into nylon spring housing and snap wings into track.

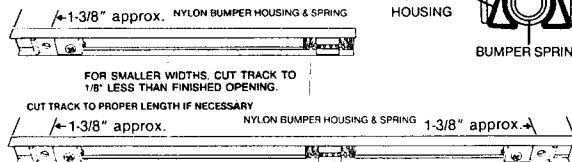
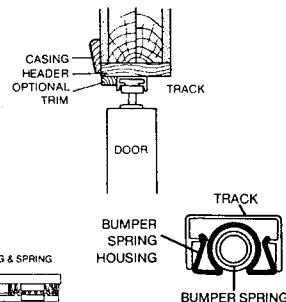

4 DOOR UNIT OVERALL TRACK LENGTH SHOULD BE 1/4" LESS THAN FINISHED OPENING